

Mounting Plates – EC Range

For use with EC Range of ABS and Polycarbonate Junction Boxes.

Specifications

Material:	Galvanised Steel 1.2mm
Treatment:	Anticorrosive Electrolysis
Properties:	Pre-drilled holes for fixing
Packaging:	Mounting Plate complete with self-tapping screws

Product images

EC450P6



EC450P7



EC450P8



EC450P9

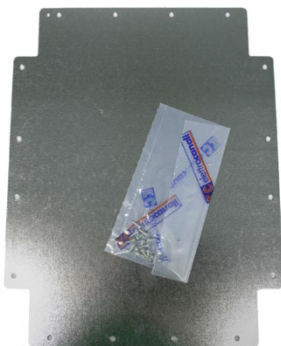

EC450P10



EC Range

Part No:	To suit EC box W	To suit EC box H
EC450P6	190	140
EC450P7	240	190
EC450P8	300	220
EC450P9	380	300
EC450P10	460	380

All dimensions are in mm

Dimensions Diagrams

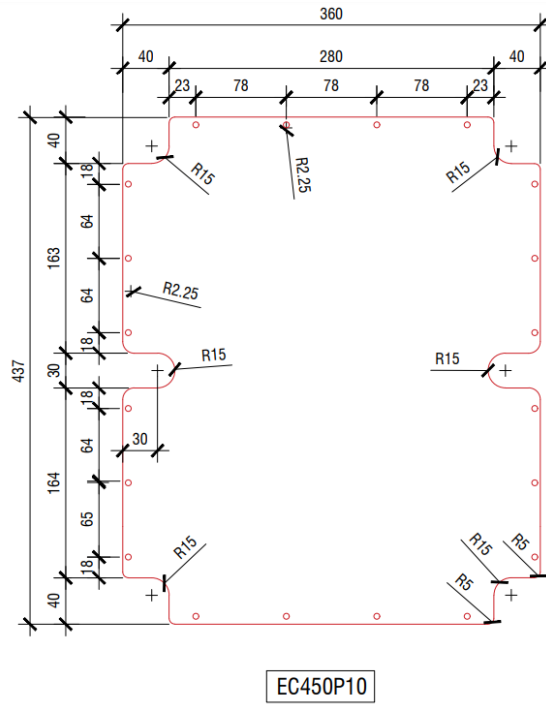
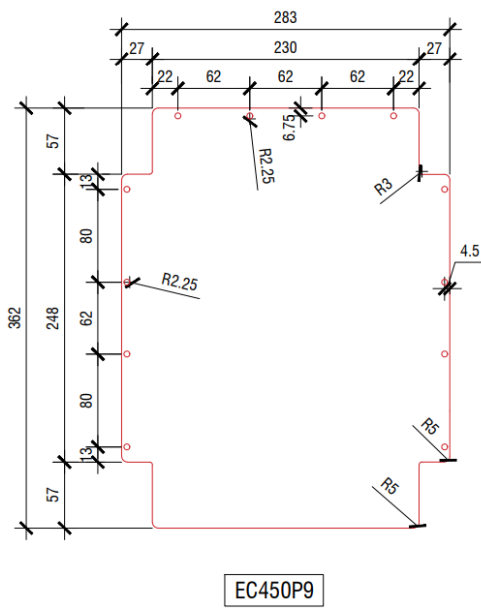
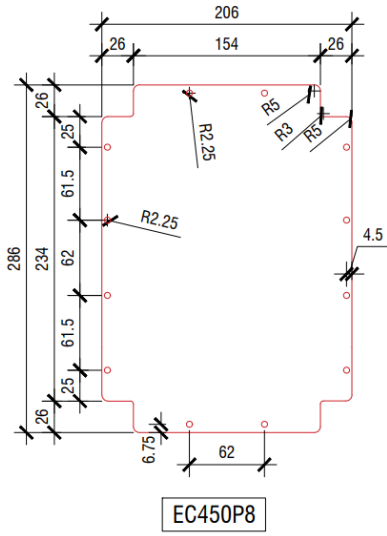
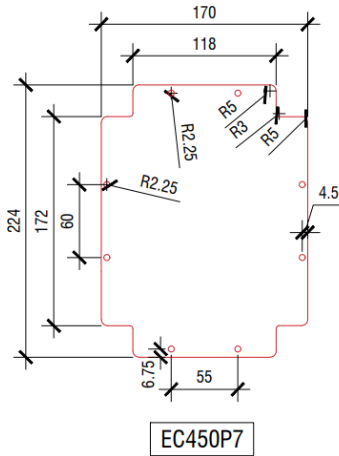
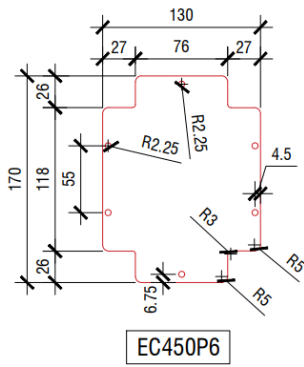

Mounting Plates - CP Range

For use with CP Range of ABS Junction Boxes.

Specifications

Material:	Galvanised Steel 1.2mm
Treatment:	Anticorrosive Electrolysis
Properties:	Pre-drilled holes for fixing
Packaging:	Mounting Plate complete with self-tapping screws

Product images

CP450P6



CP450P7



CP450P8



CP450P9



CP450P10

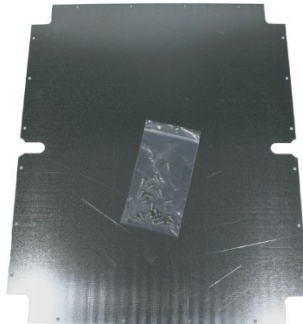

CP Range

Part No:	To suit CP box W	To suit CP box H
CP450P6	190	145
CP450P7	250	200
CP450P8	310	230
CP450P9	400	300
CP450P10	400	480

All dimensions are in mm